



1996 & Prior

MODEL YEAR VEHICLES

UNDERCARRIAGE SELECTION GUIDE

Lit. No. 29320
August 20, 2006
Revision 01

This document supersedes all editions with an earlier date.

TABLE OF CONTENTS

About the <i>U/C Selection Guide</i>	3	Nissan Undercarriage Kits	23
How to Use the <i>U/C Selection Guide</i>	4	Toyota Undercarriage Kits	24
Chevy/GMC Undercarriage Kits	5	Headlamp Reference Guide	25
Dodge Undercarriage Kits	14	Weight and Dimensional Charts	26
Ford Undercarriage Kits	19	Dimensional Diagram	27
Jeep Undercarriage Kits	21	Ballast Inquiry Sheet	28

ABBREVIATION KEY			
---	No Application	HO	High Output
4WS	Four Wheel Steering	HYD	Hydraulic
4x2	Two Wheel Drive	LP	Low Profile POWER PLOW™ Snowplow
4x4	Four Wheel Drive	LT	Light Truck Snowplow
A,Q&L	A-Frame, Quadrant & Lift Frame	MIN	Minimum
AWD	All Wheel Drive	NTEA	National Truck Equipment Association
CG	Center of Gravity	OEM	Original Equipment Manufacturer
Chassis	Chassis Cab or Cab Chassis	OHC	Overhead Cam
DIA	Diameter	PN	Part Number
DRW	Dual Rear Wheels	PP	POWER PLOW Snowplow
Ext Cab	Extended Cab Vehicle	RGAWR	Rear Gross Axle Weight Rating
FFV	Flex Fuel Vehicle	SU-2DR	Two Door Sport/Utility Vehicle
FGAWR	Front Gross Axle Weight Rating	SU-4DR	Four Door Sport/Utility Vehicle
FMVSS	Federal Motor Vehicle Safety Standards	SW	SPEEDWING™ Snowplow
GVWR	Gross Vehicle Weight Rating	w/	With
HD	Heavy Duty	w/o	Without

⚠ WARNING

New untitled vehicle installation of a snowplow requires National Highway Traffic Safety Administration altered vehicle certification labeling. Installer to verify that selected snowplow and ballast, if required, do not exceed GVWR or GAWR rating label and complies with FMVSS.

⚠ WARNING

Do not exceed GVWR or GAWR, including blade and ballast. The rating label is found on the driver-side vehicle door cornerpost.

ABOUT THE U/C SELECTION GUIDE

The *Undercarriage (U/C) Selection Guide (USG)* is designed to help you determine the appropriate snowplow components for a particular snowplow vehicle application. The information published in this guide is based on Federal Motor Vehicle Safety Standards (FMVSS) and a "representative" snowplow vehicle as defined in this guide. The vehicle includes a combined weight of 300 lb for occupants in the front seat location.

This *USG* is for specific model year vehicles only and is listed on the front cover of this guide. This guide should be saved for future reference. New selection guides will be published for the upcoming model year and so on. The instructions on page 4 explain how to use the *U/C Selection Guide*.

The "Representative Vehicle"

Knowing that today's snowplow vehicles come in a variety of sizes and configurations (such as wheel base, engine size, and handling packages), Blizzard has defined a "representative vehicle" that contains the options most likely to appear on a typical snowplow application. The "representative vehicle" includes the following options:

- 4X4 Drivetrain (unless noted)
- Spare Tire & Wheel
- Automatic Transmission
- Rear Bumper
- Air Conditioning
- Full Fluids

NOTE: If the vehicle in question does not match a vehicle listing in the *U/C Selection Guide*, or has options that differ from the "Representative Vehicle" as defined earlier, the ballast inquiry sheet must be filled out and submitted in order to determine plow availability and correct ballast amounts to maintain FMVSS compliance. Completed vehicle at no time shall exceed GVWR or GAWR.

Snowplow Product

Snowplows are considered motor vehicle equipment. The installer is ultimately responsible for determining and correctly labeling the vehicle with the addition of snowplow selection. No product selected and installed shall render inoperative the vehicle's safety compliance.

Product Changes

All information is as accurate as we can determine but is subject to revision with additional or more complete information. Blizzard reserves the right under its product improvement policy to change construction or design details and furnish equipment when so altered without reference to illustrations or specifications used. Blizzard or the vehicle manufacturer may require or recommend optional equipment for snow removal.

Ballast

When ballast is required it must be secured behind the rear wheels in a manner which prevents it from sliding during normal driving. Ballast shall not exceed 1000 lb.

Blizzard offers an optional ballast retainer kit (PN 62849) for this purpose.

HOW TO USE THE U/C SELECTION GUIDE

Selection Example:

Acme Motors 25000HD RS with POWER HITCH™ System

- Go to the section for the appropriate manufacturer.
- Starting at the left-most column, find the **model**, **year** and appropriate configuration for the vehicle. In this case, 4X4, Regular Cab, 8.0 ft. box, 6.0L V8 engine, 4800 Min. FGAWR.
- Locate the **headlight conversion harness** part number for this vehicle: 62224. See Headlamp Reference Guide in the back of the Undercarriage Selection Guide for more information.

NOTE: Not all applications require a conversion harness. If no harness is needed, the part number listed will be "n/a".

- Locate the **undercarriage** for this vehicle: B30042. Refer to any footnotes concerning conditions or requirements. For this example there are three footnotes: 1, 6 and 45.
- Locate the acceptable **blades** at the top of the table. Only those blades with ballast weights listed are valid applications. Three short dashes (—) indicates an invalid application. A question mark (?) indicates a ballast inquiry sheet must be completed.

- For this example, there are five acceptable blades. Choose the 810PP. This blade requires 600 lb of ballast.
- To order a complete snowplow package, read down from the top of the selected blade column for appropriate part numbers. Be sure to select *one* control, either joystick or touchpad. For this example, the part numbers would be:
 - B0810 (blade assembly)
 - B62109 or B62141 (control)
 - B62224 (headlight conversion harness, from Step 3 – if not n/a)
 - B30042 (undercarriage kit, from Step 4)

1996 & Prior Acme Motors

Model	Year	Body Style	DRW	Box Option	Engine Type	Min FGAWR	Min RGAWR	Min GVWR	Headlight Conversion Harness	POWER HITCH™ System		Blade Guidelines, lbs (1)											
										Undercarriage	Notes												
25000HD RS	4x4	2005	Reg Cab	No	8.0 Box	6.0L V8	4800	6084	9200	HB3/HB4 use B62224	B30042	6	---	---	---	350	350	350	---	450	600	---	---
25000HD TU	4x4	2005	Reg Cab	No	8.0 Box	6.0L V8	4500	6084	9200		B30042	6	---	---	---	350	400	450	---	800	---	---	---
25000HD VX	4x4	2005	Reg Cab	No	8.0 Box	8.1L V8	4800	6084	9200		B30042	6	---	---	---	600	700	750	---	---	---	---	---

POWER HITCH™ System											Blade Guidelines, lbs (1)												
			LT		HD			SPEEDWING™		POWER PLOW™													
			680LT	720LT	760LT ⁴⁵	760HD	800HD	860HD	760SW	860SW	810PP ⁴⁵	8611LP	8611PP										
Blade Width			6'-8"	7'-2"	7'-6"	7'-6"	8'-0"	8'-6"	7'-6"	8'-6"	8'-0" 10'-0"	8'-6" 11'-0"	8'-6" 11'-0"										
Blade Assembly			B0680	B0720	B0761	B0760	B0800	B0860	B0765	B0865	B0810	B0863	B0861										
Joystick Control			B62073										B62109										
Touch Pad Control			B62142										B62141										
													5										

- Notes:**
- Ballast amounts are based on a "Representative Vehicle," defined in the vehicle selection guide instructions, and must be modified for all other configurations for axle and GVWR compliance.
 - All New Style Only (2nd # in model # is 5 not 0) example: K15903. Refer to label in glove box for model number.

- Ballast amounts for Model 760LT and 810PP are calculated on reduced plow weights produced after March 2006 (Serial Number 0603 or later). See the weight and dimensional charts at the end of this guide for reduced, current and old plow weights.

1996 & Prior Chevy/GMC

										
LT			HD			SPEEDWING™		POWER PLOW™		
680LT	720LT	760LT ⁴⁵	760 HD	800 HD	860 HD	760SW	860SW	810PP ⁴⁵	8611LP	8611PP
6'-8"	7'-2"	7'-6"	7'-6"	8'-0"	8'-6"	7'-6"	8'-6"	8'-0" 10'-0"	8'-6" 11'-0"	8'-6" 11'-0"
B0680	B0720	B0761	B0760	B0800	B0860	B0765	B0865	B0810	B0863	B0861
Blade Width								Blade Assembly		
Joystick Control								B62073		
Touchpad Control								B62142		
								B62109		
								B62141		

Model	Year	Body Style	DRW	Box Option	Engine Type	Min F G A W R	Min R G A W R	Min G V W R	Headlight Conversion Harness	POWER HITCH™ System		Ballast Guidelines, lbs (1)												
										Under-carriage	Notes													
1/2 TON SUBURBAN (1500)	4x4	1996	All	No	All	All	All	All	2B use B62220 or HB3/HB4 use B62223	B30080	-	---	---	?	---	---	---	?	---	---	---	---	---	---
3/4 TON SUBURBAN (2500)	4x4	1996	All	No	All	All	All	All		B30043	-	---	---	---	---	?	?	?	---	?	?	?	?	---
YUKON	4x4	1996	All	No	All	All	All	All		B30080	-	---	---	---	?	---	---	---	?	---	---	---	---	---
TAHOE	4x4	1996	All	No	All	All	All	All		B30080	-	---	---	---	?	---	---	---	?	---	---	---	---	---
K1500	4x4	1996	All	No	All	All	All	All	2B use B62220 or HB3/HB4 use B62223 or LF/UF B62225	B30080	-	---	---	?	---	---	---	?	---	---	---	---	---	
K2500 HEAVY DUTY	4x4	1996	All	No	All	All	All	8600		B30043	-	---	---	---	?	?	?	---	?	?	?	?	?	---
K3500	4x4	1996	All	No	All	All	All	All	2B use B62220 or HB3/HB4 use B62223	B30043	-	---	---	---	?	?	?	---	?	?	?	?	?	---
C3500 HD 2WD W/STRAIGHT FRAME	4x2	1996	All	No	Chassis	All	All	All		10000	B30071	-	---	---	---	?	?	?	---	?	?	?	?	---
C3500 CLASSIC	4x2	1996	All	Yes	Chassis	All	All	All		10001	B30071	-	---	---	---	---	---	?	---	?	?	?	?	---
1/2 TON SUBURBAN (1500)	4x4	1995	All	No	All	All	All	All		All	B30080	-	---	---	---	?	---	---	?	---	---	---	---	---
3/4 TON SUBURBAN (2500)	4x4	1995	All	No	All	All	All	All	All	B30043	-	---	---	---	?	?	?	---	?	?	?	?	---	
K1500	4x4	1995	All	No	All	All	All	All	2B use B62220 or HB3/HB4 use B62223 or LF/UF B62225	B30080	-	---	---	?	---	---	---	?	---	---	---	---	---	
K2500 LIGHT DUTY	4x4	1995	All	No	All	All	All	7200		B30043	-	---	---	---	?	?	?	---	?	?	?	?	---	
K2500 HEAVY DUTY	4x4	1995	All	No	All	All	All	8600		B30043	-	---	---	---	?	?	?	---	?	?	?	?	---	
K3500	4x4	1995	All	No	All	All	All	All		B30043	-	---	---	---	?	?	?	---	?	?	?	?	---	
C3500 HD 2WD W/STRAIGHT FRAME	4x2	1995	All	No	Chassis	All	All	All	10000	2B use B62220 or HB3/HB4 use B62223	B30071	-	---	---	---	---	?	?	?	---	?	?	---	
C3500 CLASSIC	4x2	1995	All	Yes	Chassis	All	All	All	10001		B30071	-	---	---	---	---	---	?	---	?	?	?	?	---
BLAZER (FULL SIZE)	4x4	1994	All	No	All	All	All	All	All	2B use B62220 or HB3/HB4 use B62223	B30080	-	---	---	?	---	---	?	---	---	---	---	---	
1/2 TON SUBURBAN (1500)	4x4	1994	All	No	All	All	All	All	All		B30080	-	---	---	?	---	---	---	?	---	---	---	---	
3/4 TON SUBURBAN (2500)	4x4	1994	All	No	All	All	All	All	All		B30043	-	---	---	---	?	?	?	---	?	?	?	?	---

- Notes:**
- Ballast amounts are based on a "Representative Vehicle," defined in the vehicle selection guide instructions, and must be modified for all other configurations for axle and GVWR compliance.
 - Ballast amounts for Model 760LT and 810PP are calculated on reduced plow weights produced after March 2006 (Serial Number 0603 or later). See the weight and dimensional charts at the end of this guide for reduced, current and old plow weights.

1996 & Prior Chevy/GMC

POWER HITCH™										
LT			HD			SPEEDWING™		POWER PLOW™		
680LT	720LT	760LT ⁴⁵	760 HD	800 HD	860 HD	760SW	860SW	810PP ⁴⁵	8611LP	8611PP
6'-8"	7'-2"	7'-6"	7'-6"	8'-0"	8'-6"	7'-6"	8'-6"	8'-0" 10'-0"	8'-6" 11'-0"	8'-6" 11'-0"
B0680	B0720	B0761	B0760	B0800	B0860	B0765	B0865	B0810	B0863	B0861
Blade Width								Blade Assembly		
Joystick Control								B62073		
Touchpad Control								B62142		
								B62109		
								B62141		

Model	Year	Body Style	DRW	Box Option	Engine Type	Min F G A W R	Min R G A W R	Min G V W R	Headlight Conversion Harness	POWER HITCH™ System		Ballast Guidelines, lbs (1)											
										Under-carriage	Notes												
K2500	4x4	1985	All	No	All	All	All	All	All	2B use B62220 or HB3/HB4 use B62223 or LF/UF B62225	B30055	-	---	---	---	?	?	?	---	?	?	?	---
K10,K15	4x4	1985	All	No	All	All	All	All	All	2B use B62220 or 1A/2A use B62227	B30089	-	---	---	?	---	---	---	?	---	---	---	---
K20,K25	4x4	1985	All	No	All	All	All	All	All		B30055	-	---	---	---	?	?	?	---	?	?	?	---
K30,K35	4x4	1985	All	No	All	All	All	All	All		B30055	-	---	---	---	?	?	?	---	?	?	?	---
BLAZER/JIMMY (FULL SIZE)	4x4	1984	All	No	All	All	All	All	All	2B use B62220 or LF/UF B62225 or 1A/2A use B62227	B30089	-	---	---	?	---	---	---	?	---	---	---	---
3/4 TON SUBURBAN (2500)	4x4	1984	All	No	All	All	All	All	All	2B use B62220 or 1A/2A use B62227	B30055	-	---	---	---	?	?	?	---	?	?	?	---
K1500	4x4	1984	All	No	All	All	All	All	All		B30089	-	---	---	?	---	---	---	?	---	---	---	---
K2500	4x4	1984	All	No	All	All	All	All	All	2B use B62220 or HB3/HB4 use B62223 or LF/UF B62225	B30055	-	---	---	---	?	?	?	---	?	?	?	---
K10,K15	4x4	1984	All	No	All	All	All	All	All	2B use B62220 or 1A/2A use B62227	B30089	-	---	---	?	---	---	---	?	---	---	---	---
K20,K25	4x4	1984	All	No	All	All	All	All	All		B30055	-	---	---	---	?	?	?	---	?	?	?	---
K30,K35	4x4	1984	All	No	All	All	All	All	All		B30055	-	---	---	---	?	?	?	---	?	?	?	---

- Notes:**
- Ballast amounts are based on a "Representative Vehicle," defined in the vehicle selection guide instructions, and must be modified for all other configurations for axle and GVWR compliance.
 - Ballast amounts for Model 760LT and 810PP are calculated on reduced plow weights produced after March 2006 (Serial Number 0603 or later). See the weight and dimensional charts at the end of this guide for reduced, current and old plow weights.

1996 & Prior Chevy/GMC

										
LT			HD			SPEEDWING™		POWER PLOW™		
680LT	720LT	760LT ⁴⁵	760 HD	800 HD	860 HD	760SW	860SW	810PP ⁴⁵	8611LP	8611PP
6'-8"	7'-2"	7'-6"	7'-6"	8'-0"	8'-6"	7'-6"	8'-6"	8'-0" 10'-0"	8'-6" 11'-0"	8'-6" 11'-0"
B0680	B0720	B0761	B0760	B0800	B0860	B0765	B0865	B0810	B0863	B0861
Blade Width								Blade Assembly		
Joystick Control								B62073		
Touchpad Control								B62142		
								B62109		
								B62141		

Model	Year	Body Style	DRW	Box Option	Engine Type	Min F G A W R	Min R G A W R	Min G V W R	Headlight Conversion Harness	POWER HITCH™ System		Ballast Guidelines, lbs (1)											
										Under-carriage	Notes												
3/4 TON SUBURBAN (2500)	4x4	1983	All	No	All	All	All	All	All	2B use B62220 or 1A/2A use B62227	B30055	-	---	---	---	?	?	?	---	?	?	?	---
K1500	4x4	1983	All	No	All	All	All	All	All	2B use B62220 or 1A/2A use B62227	B30089	-	---	---	?	---	---	---	?	---	---	---	---
K2500	4x4	1983	All	No	All	All	All	All	All	2B use B62220 or HB3/HB4 use B62223 or LF/UF B62225	B30055	-	---	---	---	?	?	?	---	?	?	?	---
K10,K15	4x4	1983	All	No	All	All	All	All	All	2B use B62220 or 1A/2A use B62227	B30089	-	---	---	?	---	---	---	?	---	---	---	---
K20,K25	4x4	1983	All	No	All	All	All	All	All	2B use B62220 or 1A/2A use B62227	B30055	-	---	---	---	?	?	?	---	?	?	?	---
K30,K35	4x4	1983	All	No	All	All	All	All	All	2B use B62220 or 1A/2A use B62227	B30055	-	---	---	---	?	?	?	---	?	?	?	---
BLAZER/JIMMY (FULL SIZE)	4x4	1982	All	No	All	All	All	All	All	2B use B62220 or LF/UF B62225 or 1A/2A use B62227	B30089	-	---	---	?	---	---	---	?	---	---	---	---
3/4 TON SUBURBAN (2500)	4x4	1982	All	No	All	All	All	All	All	2B use B62220 or 1A/2A use B62227	B30055	-	---	---	---	?	?	?	---	?	?	?	---
K1500	4x4	1982	All	No	All	All	All	All	All	2B use B62220 or 1A/2A use B62227	B30089	-	---	---	?	---	---	---	?	---	---	---	---

- Notes:**
- Ballast amounts are based on a "Representative Vehicle," defined in the vehicle selection guide instructions, and must be modified for all other configurations for axle and GVWR compliance.
 - Ballast amounts for Model 760LT and 810PP are calculated on reduced plow weights produced after March 2006 (Serial Number 0603 or later). See the weight and dimensional charts at the end of this guide for reduced, current and old plow weights.

1996 & Prior Chevy/GMC

											
LT			HD			SPEEDWING™		POWER PLOW™			
680LT	720LT	760LT ⁴⁵	760 HD	800 HD	860 HD	760SW	860SW	810PP ⁴⁵	8611LP	8611PP	
Blade Width	6'-8"	7'-2"	7'-6"	7'-6"	8'-0"	8'-6"	7'-6"	8'-6"	8'-0" 10'-0"	8'-6" 11'-0"	8'-6" 11'-0"
Blade Assembly	B0680	B0720	B0761	B0760	B0800	B0860	B0765	B0865	B0810	B0863	B0861
Joystick Control	B62073								B62109		
Touchpad Control	B62142								B62141		

Model	Year	Body Style	DRW	Box Option	Engine Type	Min F G A W R	Min R G A W R	Min G V W R	Headlight Conversion Harness	POWER HITCH™ System		Ballast Guidelines, lbs (1)											
										Under-carriage	Notes												
K2500	4x4	1982	All	No	All	All	All	All	All	2B use B62220 or HB3/HB4 use B62223 or LF/UF B62225	B30055	-	---	---	---	?	?	?	---	?	?	?	---
K10,K15	4x4	1982	All	No	All	All	All	All	All	2B use B62220 or 1A/2A use B62227	B30089	-	---	---	?	---	---	---	?	---	---	---	---
K20,K25	4x4	1982	All	No	All	All	All	All	All		B30055	-	---	---	---	?	?	?	---	?	?	?	---
K30,K35	4x4	1982	All	No	All	All	All	All	All		B30055	-	---	---	---	?	?	?	---	?	?	?	---
BLAZER/JIMMY (FULL SIZE)	4x4	1981	All	No	All	All	All	All	All	2B use B62220 or LF/UF B62225 or 1A/2A use B62227	B30089	-	---	---	?	---	---	---	?	---	---	---	---
K1500	4x4	1981	All	No	All	All	All	All	All	2B use B62220 or 1A/2A use B62227	B30089	-	---	---	?	---	---	---	?	---	---	---	---
K10,K15	4x4	1981	All	No	All	All	All	All	All		B30089	-	---	---	?	---	---	---	?	---	---	---	---
BLAZER/JIMMY (FULL SIZE)	4x4	1980	All	No	All	All	All	All	All		B30089	-	---	---	?	---	---	---	?	---	---	---	---
K1500	4x4	1980	All	No	All	All	All	All	All		B30089	-	---	---	?	---	---	---	?	---	---	---	---
K10,K15	4x4	1980	All	No	All	All	All	All	All		B30089	-	---	---	?	---	---	---	?	---	---	---	---
K10,K15	4x4	1980	All	No	All	All	All	All	All		B30089	-	---	---	?	---	---	---	?	---	---	---	---

- Notes:**
- Ballast amounts are based on a "Representative Vehicle," defined in the vehicle selection guide instructions, and must be modified for all other configurations for axle and GVWR compliance.
 - Ballast amounts for Model 760LT and 810PP are calculated on reduced plow weights produced after March 2006 (Serial Number 0603 or later). See the weight and dimensional charts at the end of this guide for reduced, current and old plow weights.

1996 & Prior Dodge

LT			HD			SPEEDWING™		POWER PLOW™		
680LT	720LT	760LT ⁴⁵	760 HD	800 HD	860 HD	760SW	860SW	810PP ⁴⁵	8611LP	8611PP
6'-8"	7'-2"	7'-6"	7'-6"	8'-0"	8'-6"	7'-6"	8'-6"	8'-0" 10'-0"	8'-6" 11'-0"	8'-6" 11'-0"
B0680	B0720	B0761	B0760	B0800	B0860	B0765	B0865	B0810	B0863	B0861
Blade Width								Blade Assembly		
Joystick Control								B62073		
Touchpad Control								B62142		
								B62109		
								B62141		

Model	Year	Body Style	DRW	Box Option	Engine Type	Min F G A W R	Min R G A W R	Min G V W R	Headlight Conversion Harness	POWER HITCH™ System		Ballast Guidelines, lbs (1)										
										Under-carriage	Notes											
W250	4x4	1975	All	No	All	All	All	All	2B/2D use B62220 or 1A/2A use B62227	B32034	-	---	---	---	?	?	?	---	?	?	?	---
W350	4x4	1975	All	No	All	All	All	All		B32034	-	---	---	---	?	?	?	---	?	?	?	---
W250	4x4	1974	All	No	All	All	All	All		B32034	-	---	---	---	?	?	?	---	?	?	?	---
W350	4x4	1974	All	No	All	All	All	All		B32034	-	---	---	---	?	?	?	---	?	?	?	---
W250	4x4	1973	All	No	All	All	All	All		B32034	-	---	---	---	?	?	?	---	?	?	?	---
W350	4x4	1973	All	No	All	All	All	All		B32034	-	---	---	---	?	?	?	---	?	?	?	---

- Notes:**
- Ballast amounts are based on a "Representative Vehicle," defined in the vehicle selection guide instructions, and must be modified for all other configurations for axle and GVWR compliance.
 - Ballast amounts for Model 760LT and 810PP are calculated on reduced plow weights produced after March 2006 (Serial Number 0603 or later). See the weight and dimensional charts at the end of this guide for reduced, current and old plow weights.

1996 & Prior Ford

										
LT			HD			SPEEDWING™		POWER PLOW™		
680LT	720LT	760LT ⁴⁵	760 HD	800 HD	860 HD	760SW	860SW	810PP ⁴⁵	8611LP	8611PP
6'-8"	7'-2"	7'-6"	7'-6"	8'-0"	8'-6"	7'-6"	8'-6"	8'-0" 10'-0"	8'-6" 11'-0"	8'-6" 11'-0"
B0680	B0720	B0761	B0760	B0800	B0860	B0765	B0865	B0810	B0863	B0861
Blade Width								Blade Assembly		
Joystick Control								B62073		
Touchpad Control								B62142		

Model	Year	Body Style	DRW	Box Option	Engine Type	Min F G A W R	Min R G A W R	Min G V W R	Headlight Conversion Harness	POWER HITCH™ System		Ballast Guidelines, lbs (1)												
										Under-carriage	Notes													
EXPLORER	4x4	1996	All	No	All	All	All	All	HB5 use B62222	B31142	-	?	?	---	---	---	---	---	---	---	---	---	---	
F150	4x4	1996	All	No	All	All	All	All		B31056	-	---	---	?	---	---	---	?	---	---	---	---	---	---
F250HD	4x4	1996	All	No	All	All	All	All		B31036	-	---	---	---	?	?	?	---	?	?	?	?	?	---
F250HD W/ SUPERCAB	4x4	1996	All	No	All	All	All	All		B31036	-	---	---	---	?	?	?	---	?	?	?	?	?	---
F350	4x4	1996	All	No	All	All	All	All		B31036	-	---	---	---	?	?	?	---	?	?	?	?	?	---
F350	4x2	1996	All	No	All	All	All	All		10000	B31036	-	---	---	---	?	?	?	---	?	?	?	?	---
EXPLORER	4x4	1995	All	No	All	All	All	All		B31142	-	?	?	---	---	---	---	---	---	---	---	---	---	---
F150	4x4	1995	All	No	All	All	All	All		B31056	-	---	---	?	---	---	---	?	---	---	---	---	---	---
F250HD	4x4	1995	All	No	All	All	All	All		B31036	-	---	---	---	?	?	?	---	?	?	?	?	?	---
F250HD W/ SUPERCAB	4x4	1995	All	No	All	All	All	All		B31036	-	---	---	---	?	?	?	---	?	?	?	?	?	---
F350	4x4	1995	All	No	All	All	All	All		B31036	-	---	---	---	?	?	?	---	?	?	?	?	?	---
F350	4x2	1995	All	No	All	All	All	All		10000	B31036	-	---	---	---	?	?	?	---	?	?	?	?	---
F150	4x4	1994	All	No	All	All	All	All		B31056	-	---	---	?	---	---	---	?	---	---	---	---	---	---
F250HD	4x4	1994	All	No	All	All	All	All		B31036	-	---	---	---	?	?	?	---	?	?	?	?	?	---
F350	4x4	1994	All	No	All	All	All	All		B31036	-	---	---	---	?	?	?	---	?	?	?	?	?	---
F350	4x2	1994	All	No	All	All	All	All		10000	B31036	-	---	---	---	?	?	?	---	?	?	?	?	---
F150	4x4	1993	All	No	All	All	All	All		B31056	-	---	---	?	---	---	---	?	---	---	---	---	---	---
F250HD	4x4	1993	All	No	All	All	All	All		B31036	-	---	---	---	?	?	?	---	?	?	?	?	?	---
F350	4x4	1993	All	No	All	All	All	All		B31036	-	---	---	---	?	?	?	---	?	?	?	?	?	---
F350	4x2	1993	All	No	All	All	All	All		10000	B31036	-	---	---	---	?	?	?	---	?	?	?	?	---
F150	4x4	1992	All	No	All	All	All	All	B31056	-	---	---	?	---	---	---	?	---	---	---	---	---	---	
F250HD	4x4	1992	All	No	All	All	All	All	B31036	-	---	---	---	?	?	?	---	?	?	?	?	?	---	
F350	4x4	1992	All	No	All	All	All	All	B31036	-	---	---	---	?	?	?	---	?	?	?	?	?	---	
F350	4x2	1992	All	No	All	All	All	All	10000	B31036	-	---	---	---	?	?	?	---	?	?	?	?	---	
F150	4x4	1991	All	No	All	All	All	All	B31074	-	---	---	?	---	---	---	?	---	---	---	---	---	---	
F250	4x4	1991	All	No	All	All	All	All	B31041	-	---	---	---	?	?	?	---	?	?	?	?	?	---	
F350	4x4	1991	All	No	All	All	All	All	B31041	-	---	---	---	?	?	?	---	?	?	?	?	?	---	
F150	4x4	1990	All	No	All	All	All	All	B31074	-	---	---	?	---	---	---	?	---	---	---	---	---	---	
F250	4x4	1990	All	No	All	All	All	All	B31041	-	---	---	---	?	?	?	---	?	?	?	?	?	---	
F350	4x4	1990	All	No	All	All	All	All	B31041	-	---	---	---	?	?	?	---	?	?	?	?	?	---	

Notes:
 1. Ballast amounts are based on a "Representative Vehicle," defined in the vehicle selection guide instructions, and must be modified for all other configurations for axle and GVWR compliance.
 45. Ballast amounts for Model 760LT and 810PP are calculated on reduced plow weights produced after March 2006 (Serial Number 0603 or later). See the weight and dimensional charts at the end of this guide for reduced, current and old plow weights.

1996 & Prior Toyota

																							
LT			HD			SPEEDWING™		POWER PLOW™															
680LT	720LT	760LT ⁴⁵	760 HD	800 HD	860 HD	760SW	860SW	810PP ⁴⁵	8611LP	8611PP													
Blade Width	6'-8"	7'-2"	7'-6"	7'-6"	8'-0"	8'-6"	7'-6"	8'-6"	8'-0"	8'-6"	8'-6"												
Blade Assembly	B0680	B0720	B0761	B0760	B0800	B0860	B0765	B0865	B0810	B0863	B0861												
Joystick Control	B62073								B62109														
Touchpad Control	B62142								B62141														
Model	Year	Body Style	DRW	Box Option	Engine Type	Min F G A W R	Min R G A W R	Min G V W R	Headlight Conversion Harness	POWER HITCH™ System	Ballast Guidelines, lbs (1)												
TACOMA	4x4	1996	All	No	All	All	All	All	2B use	B35018	-	?	?	---	---	---	---	---	---	---	---	---	---
TACOMA	4x4	1995	All	No	All	All	All	All	B62220	B35018	-	?	?	---	---	---	---	---	---	---	---	---	---

- Notes:**
- Ballast amounts are based on a "Representative Vehicle," defined in the vehicle selection guide instructions, and must be modified for all other configurations for axle and GVWR compliance.
 - Ballast amounts for Model 760LT and 810PP are calculated on reduced plow weights produced after March 2006 (Serial Number 0603 or later). See the weight and dimensional charts at the end of this guide for reduced, current and old plow weights.

HEADLAMP REFERENCE GUIDE

NOTE: The lamp type is usually embossed in the headlamp lens.

NOTE: Blue ground wires may be LT or DK BLU, w/ or w/o WHT stripe, depending on harness.

Headlamp Type	Bulb Type	Headlamp Type	Bulb Type
LF	H4703	2E1	H6545
UF	H4701	H13	9008
1A1	H4651	HB1	9004
2A1	H4652(GMC/Chevy)	HB2	9003
2A1	H4656 (Mitsubishi)	HB3	9005
2B1	H6054	HB4	9006
2D1	H6024	HB5	9007

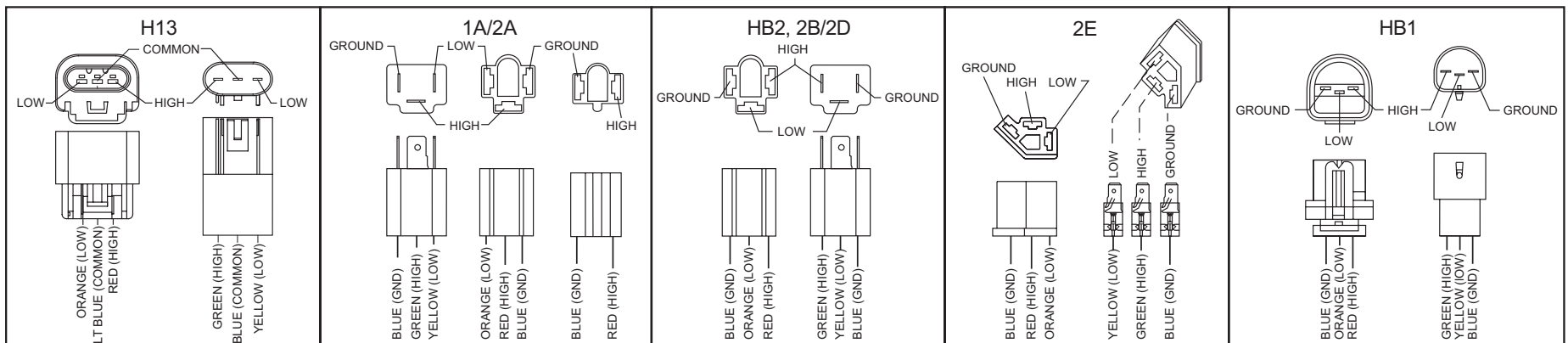
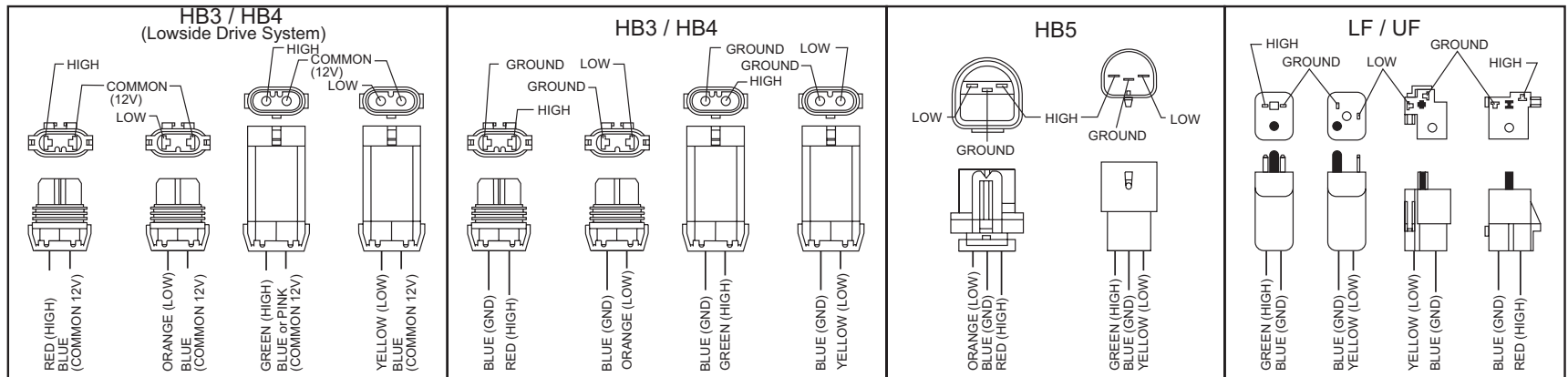

WEIGHT AND DIMENSIONAL CHARTS

Snowplows and Accessories Information					
Snowplows		Accessories – Part Number (Actual Weight in lb)			Variable
Model	Weight (lb)	Snow Deflectors	Airfoils	POLAR EDGE [®] Polyurethane Cutting Edges w/Hardware	Z (in)
680LT	334	–	–	–	18.0
720LT	348	–	–	–	19.0
760LT ¹	563	B61243 (21.3)	B81041 (9.3)	B61544 (52.3)	24.5
760LT ²	540	B61243 (21.3)	B81041 (9.3)	B61544 (52.3)	24.5
760HD	717	B61242 (22.3)	B52093 (13.3)	B61544 (52.3)	26.3
800HD	734	B61260 (23.3)	B52093 (13.3)	B61543 (55.3)	26.8
860HD	743	B61545 (27.3)	B52093 (13.3)	B61542 (59.3)	26.8
760SW	642	–	–	–	25.7
860SW	812	–	–	–	27.4
810PP ¹	1012	B61241 (38.3)	B52093 (13.3)	B61536 (99.6)	29.5
810PP ²	964	B61241 (38.3)	B52093 (13.3)	B61536 (99.6)	29.5
8611LP	1083	B52087 (41.3)	B52092 (14.3)	–	29.7
8611PP	1422	B52087 (41.3)	B52092 (14.3)	B61541 (141.1)	33.6

1. manufacture date before March 2006

2. manufacture date on or after March 2006

NOTE: The addition of accessories to a snowplow or vehicle will require additional ballast above any amount published in this guide in order to maintain FMVSS compliance. Completed vehicle with additional accessories shall not exceed GVWR or GAWR.

NOTE: An abbreviation key is on page 2.

NOTE: See next page for variable definitions.

Undercarriage (U/C) Information*							
U/C #	Weight (lb)	X (in)	Y (in)	U/C #	Weight (lb)	X (in)	Y (in)
B30042	107.0	33.9	3.0	B32013	137.0	33.5	3.5
B30043	83.0	31.6	3.1	B32034	136.0	33.5	3.5
B30055	104.0	36.2	4.9	B32037	56.0	34.3	7.3
B30071	110.0	36.2	4.9	B32048	125.0	36.4	3.9
B30080	113.0	31.6	3.1	B32057	139.0	36.2	4.9
B30087	111.0	35.2	3.8	B32085	83.0	24.4	0.3
B30089	94.0	36.2	4.9	B32157	85.0	36.2	4.9
B30172	209.0	24.4	0.3	B32188	83.0	36.2	4.9
B30174	79.0	34.7	7.7	B32207	64.0	24.4	0.3
B30185	61.0	33.2	1.6	B32214	68.0	34.3	7.3
B30186	84.0	34.8	4.3	B32221	80.0	34.8	4.3
B30191	192.0	33.9	3.0	B33010	147.0	34.1	6.0
B31036	92.0	34.8	4.3	B33038	236.0	33.5	3.5
B31041	106.0	34.8	4.3	B35018	78.0	31.6	3.1
B31046	79.0	34.7	7.7	B35028	68.0	31.6	3.1
B31056	66.0	31.9	1.2	B35037	50.0	33.9	3.0
B31074	82.0	34.8	4.3	B35045	71.0	34.8	4.3
B31085	83.0	35.2	3.8	B35062	35.0	15.0	5.0
B31142	92.0	31.9	1.2	B35065	69.0	34.8	4.3
B31184	114.0	34.8	4.3	B35101	39.0	**	**
B31219	175.0	34.1	6.0	B35114	78.0	31.6	3.1
B31250	175.0	34.1	6.0				

* These weights include the weight of the light tower when applicable.

** Information to be provided in a future revision of this guide.

DIMENSIONAL DIAGRAM

Variables:

X = Distance from center of front axle to hitch pin

Y = Distance from hitch pin to CG of undercarriage.

Z = Distance from hitch pin to CG of snowplow.

Available vehicle capacities for aftermarket equipment and components can be determined by using the above information along with information provided by the vehicle manufacturer's Body Builder Guides. Follow all requirements and recommendations as stated by vehicle manufacturer.

NOTE: An abbreviation key is on page 2.

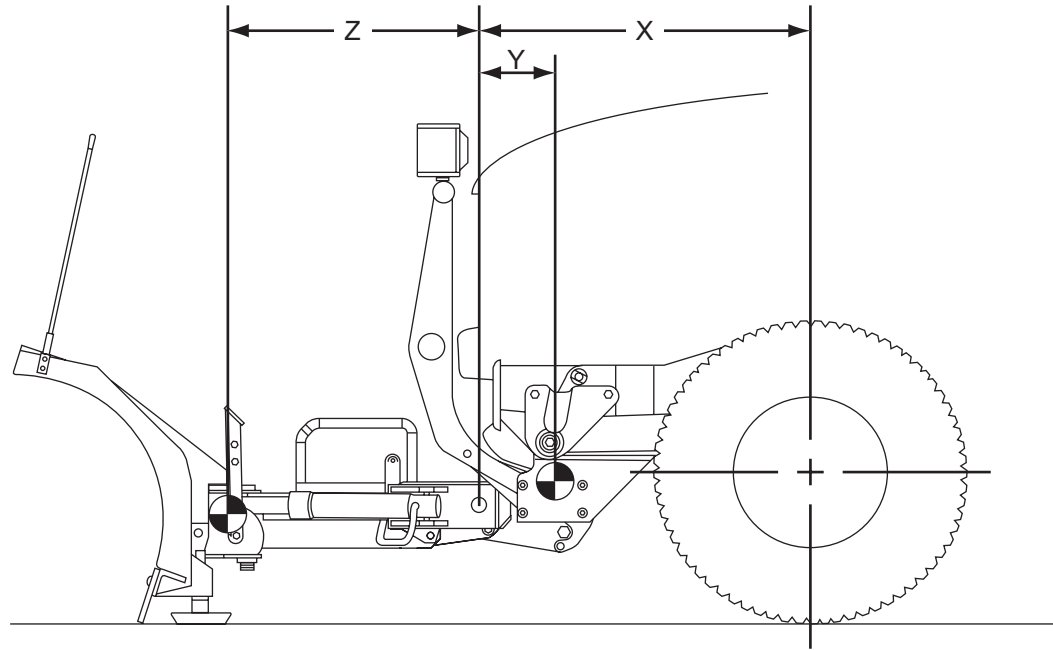

VEHICLE AND PLOW APPLICATION INQUIRY SHEET



Blizzard
 P.O. Box 245038
 Milwaukee, WI 53224-9538

Telephone (888) 860-8600
 Fax (877) 254-9329

DISTRIBUTOR		TEL
		FAX

CUSTOMER		
VIN		DATE BUILT

VEHICLE INFORMATION

YEAR			
MAKE			
MODEL			
DRIVE TRAIN	<input type="checkbox"/> 4x2 (over 10,000 lb. GVW only)	<input type="checkbox"/> 4x4	<input type="checkbox"/> ALL WHEEL <input style="width: 50px;" type="text"/> OTHER
DRW (Dual Rear Wheels)	<input type="checkbox"/> YES	<input type="checkbox"/> NO	
BODY STYLE	<input type="checkbox"/> REG CAB	<input type="checkbox"/> EXT CAB	<input style="width: 50px;" type="text"/> OTHER
BOX OPTION (S)	<input type="checkbox"/> DUMP BOX	<input type="checkbox"/> STAKE BED	<input style="width: 50px;" type="text"/> OTHER
ENGINE TYPE			
GFAWR			
GRAWR			
GVWR			

HORIZONTAL DISTANCE DESCRIPTION

L31	DRIVERS hip point; in MIDDLE position, to Centerline of FRONT axle	(in.)
L101	Between axles (Wheelbase)	(in.)
L104	Middle of FRONT bumper to centerline of FRONT axle	(in.)
	Middle of ballast location to centerline of REAR axle	(in.)

VEHICLE WEIGHT (TRUCK MUST BE WEIGHED COMPLETE AND EMPTY (-) OCCUPANTS, PLOW & UNDERCARRIAGE)

FRONT (lb.)	REAR (lb.)

FUEL TANKS (ONLY NEEDED IF WEIGHED VEHICLE NOT FULLY FUELED)

	LEVEL (see below)	CAPACITY (gal.)	LOCATION FROM AXLE TO CENTER OF TANK(in.)
FRONT OF AXLE			
REAR OF AXLE			

FUEL LEVEL (EMPTY = 0, HALF = 1/2, FULL = 1)

THIS FORM *MUST* BE COMPLETED IN ITS ENTIRETY. ANY FORMS CONTAINING INCOMPLETE INFORMATION WILL NOT BE CONSIDERED. PLEASE RETURN VIA FAX (877) 254-9329.

Blizzard and the vehicle manufacturer may require or recommend optional equipment for snow removal.
 See the BLIZZARD® *Undercarriage Selection Guide* for additional product information.

Notes:



Blizzard
P.O. Box 245038
Milwaukee, WI 53224-9538
www.blizzardplows.com

 A DIVISION OF DOUGLAS DYNAMICS, L.L.C.

Blizzard reserves the right under its product improvement policy to change construction or design details and furnish equipment when so altered without reference to illustrations or specifications used. Blizzard or the vehicle manufacturer may require or recommend optional equipment for snow removal. Do not exceed vehicle ratings with a snowplow. Blizzard offers a limited warranty for all snowplows and accessories. See separately printed page for this important information. The following are registered (®) or unregistered (™) trademarks of Douglas Dynamics, L.L.C.: BLIZZARD®, BLIZZARD POWER PLOW®, POWER PLOW™, POWER HITCH™, SPEEDWING™.

Printed in U.S.A.